



GENERAL SPECIFICATIONS

- Ventilation of technical, industrial and commercial premises in general, particularly preferred for every kind of burner (Diesel oil, LPG and Natural gas) and aspiration purpose where high pressures essential.
- Static and dynamic vibration defects are recovered after production appropriate with ISO 1940 norms. Rotation of fans are signed on casing. Please determine fan position while giving order.
- The casing is formed from the St 37.2 steel sheets with integral supports. The grey (RAL 7036) paint finish is applied after production, optional hot dip galvanization, furnace paint or epoxy paint is available.
- EYK series are manufactured between 200 - 2.000 m³/h for 100 - 1.800 mmWG pressures.

SPECIFIC SPECIFICATIONS

APPLICATIONS

Ventilation of technical, industrial and commercial premises in general, particularly preferred for every kind of burner (Diesel oil, LPG and Natural gas) and aspiration purpose where high pressures essential.

CONSTRUCTION

All parts of the ERR Centrifugal Roof Fans are made of St 37 steel sheets, except special applications. The grey (RAL 7036) paint finish is applied after production, optional hot dip galvanization, furnace paint or epoxy paint is available.

ELECTRIC MOTORS

EYK series are direct driven

ACCESSORIES

You can use following accessories with EYK Models:

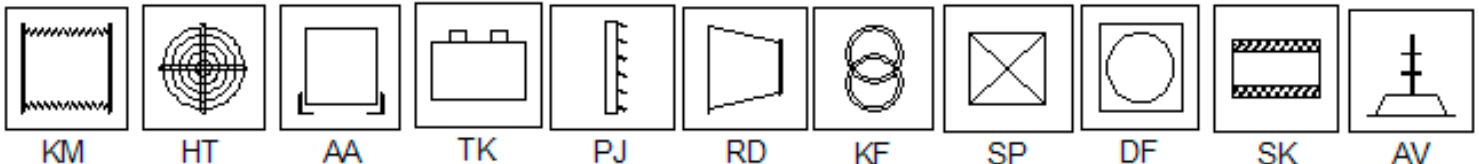

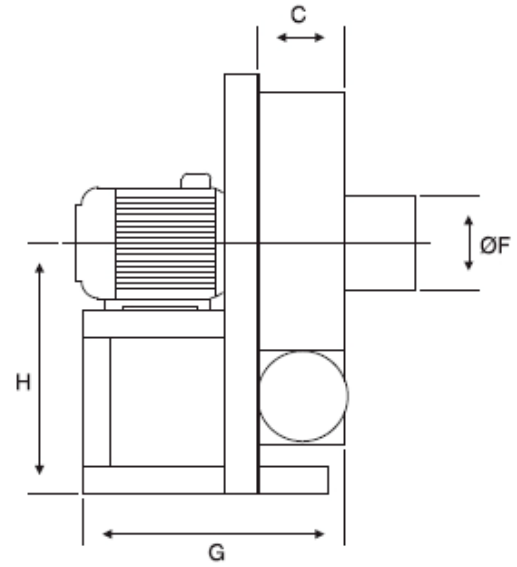
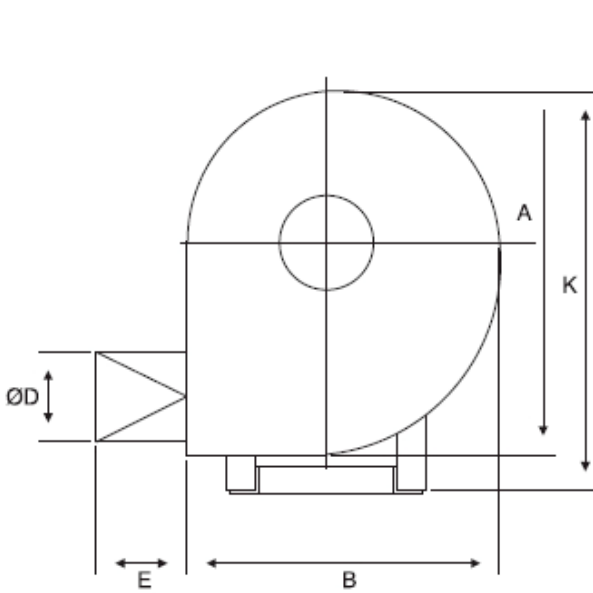

Type	Rated Output (kW)	Rpm	Dimensions in mm								
			A	B	C	ØD	E	ØF	G	H	K
EYK 10	0.37	2850	467	432	60	80	100	105	243	292	507
EYK 20	0.75	2850	520	484	60	80	100	115	254	320	560
EYK 30	1.1	2850	566	530	60	80	100	125	254	344	606
EYK 40	1.5	2850	620	580	70	90	100	135	289	368	660
EYK 50	2.2	2850	679	640	70	90	100	145	314	397	719
EYK 60	3	2850	739	698	70	90	100	155	334	439	789
EYK 65	4	2850	770	730	65	95	110	170	350	460	820
EYK 70	4	2850	770	730	75	100	110	170	360	460	820
EYK 75	5.5	2850	804	760	75	110	110	180	380	475	854
EYK 80	5.5	2850	804	760	85	115	120	180	390	475	854
EYK 85	7.5	2850	852	802	90	130	120	190	425	500	902
EYK 90	7.5	2850	852	802	100	140	120	190	435	500	902



CENTRIFUGAL FANS CODING SYSTEM

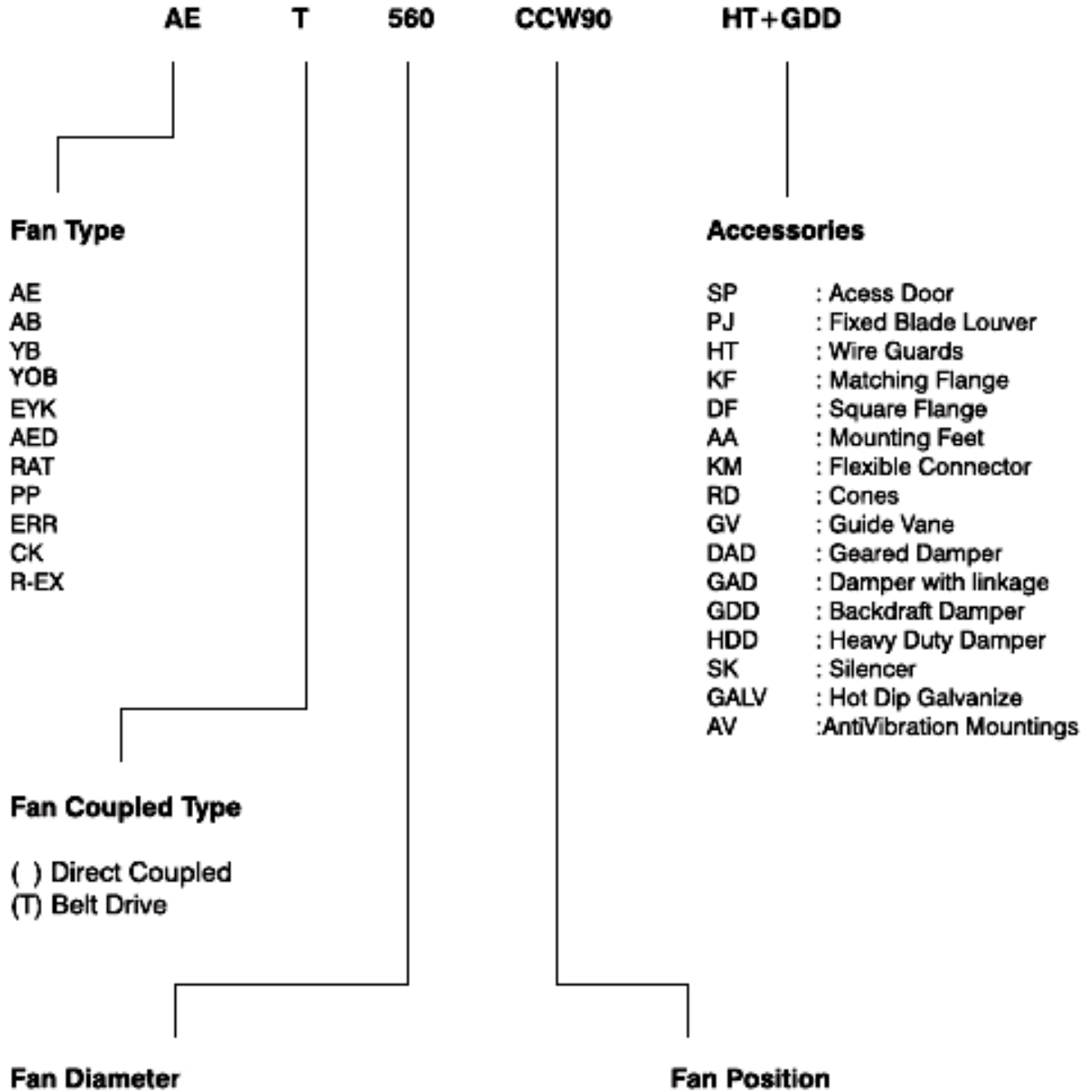
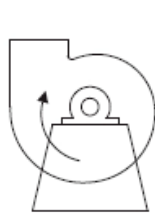
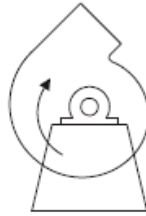



TABLE OF FAN POSITIONS - THE LOOK FROM DRIVE SIDE



Clockwise
Up Blast
CW 360



Clockwise
Top Angular Up
CW 45

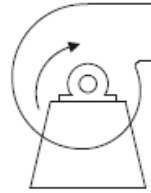

Clockwise
Top Horizontal
CW 90

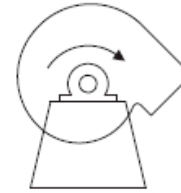

Clockwise
Top Angular Down
CW 135

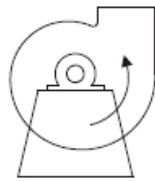

Clockwise
Up Blast
CCW 360

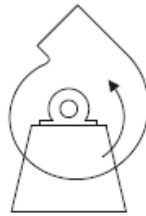

Clockwise
Top Angular Up
CCW 45

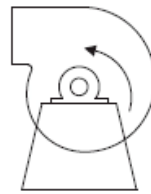

Clockwise
Top Horizontal
CCW 90

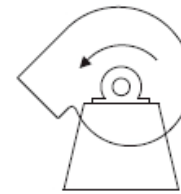

Clockwise
Top Angular Down
CCW 135

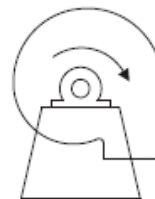

Clockwise
Downblast
CW 180



Clockwise
Bottom Angular Down
CW 225



Clockwise
Bottom Horizontal
CW270

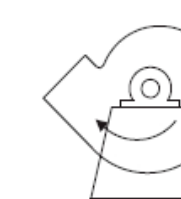

Clockwise
Bottom Angular Up
CW 315



Clockwise
Downblast
CCW 180



Clockwise
Bottom Angular Down
CCW 225

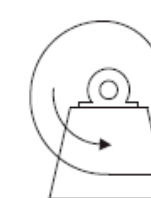

Clockwise
Bottom Horizontal
CCW270

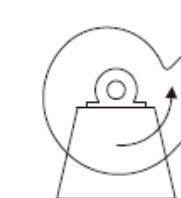

Clockwise
Bottom Angular Up
CCW 315

DESIGNATION FOR ROTATION AND DISCHARGE OF CENTRIFUGAL FANS